

ULTRASONIC THICKNESS GAUGE

A1208

OPERATION MANUAL



Acoustic Control Systems – ACS Group
Saarbrücken, Germany 2019



CONTENTS

1 DESCRIPTION AND OPERATION.....	6
1.1 Intended use.....	6
1.1.1 Intended use and range of application.....	6
1.1.2 Operating conditions.....	6
1.2 Technical specifications.....	7
1.3 Arrangement and operation.....	8
1.3.1 Arrangement.....	8
1.3.2 Operating principle.....	9
1.3.3 Operating modes.....	9
1.3.4 Display of the device.....	10
1.3.5 The device keyboard.....	13
2 INTENDED USE.....	14
2.1 Operational restrictions.....	14
2.2 Preparing the device for use.....	14
2.2.1 Preparation of the surface.....	14
2.2.2 Connection of the transducer.....	14
2.2.3 Switching the device On/Off.....	15
2.2.4 The setup of the device to the parameters of the used PET.....	15

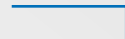

2.3 Using the device	18
2.3.1 Work with the device	18
2.3.2 The SETUP mode	18
2.3.3 The MONITORING Mode	33
2.3.4 The MEMORY Mode	35
3 MAINTENANCE	40
3.1 Battery	40
3.2 Charging the battery	40
3.3 Possible malfunctions	40
4 STORAGE	41
5 TRANSPORTATION	42
APPENDIX A	43

The present operation manual (hereinafter referred to as the “Manual”) contains technical specifications, description and operating principle of the device as well as information necessary for correct operation of the ultrasonic A1208 thickness gauge (hereinafter referred to as “thickness gauge” or “device”).

Prior to start working with the device, please carefully read the manual.

The manufacturer continuously improves the possibilities of the device, its reliability and comfort of operation. This may result in some minor changes, not given in the present revision of the manual. These changes do not affect the technical specifications of the device.

The instrument is manufactured by:

ACS-Solutions GmbH
Science Park 2
66123 Saarbrücken, Germany

Phone: +49 (0) 681-96592270
Fax: +49 (0) 681-96592280
E-mail: info@acs-international.com
Website: www.acs-international.com

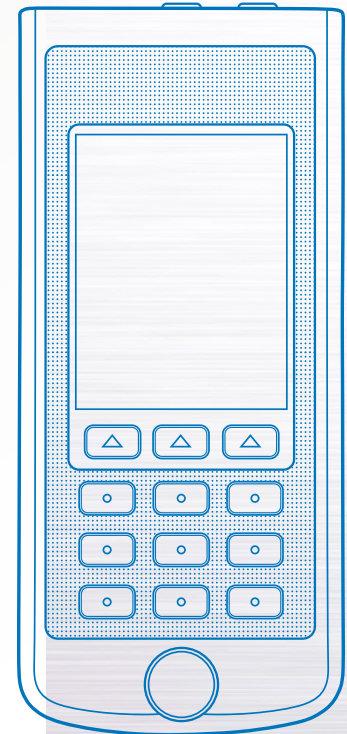



1

DESCRIPTION AND OPERATION

1.1 THE INTENDED USE

1.1.1 Intended use and range of application

The ultrasonic cold-resistant thickness gauge A1208 is used for measuring the thickness of pipe walls (including bends), boilers, cylinders, vessels under pressure, covers and other products from ferrous and nonferrous metals, with smooth or rough and corrosive surfaces, and also products from plastic and other materials with high fading of the ultrasonic sound at a unilateral access to the surface of such products.

The device can be used in laboratories, work shops or in the field in various industries. Prior to use the device, it is necessary to perform a preliminary preparation of the surface and use a contact liquid, e.g. oil, water, glycerin, special contact liquids or gels for ultrasonic testing.

The thickness gauge is equipped with a special patented system of automatic adaptation to the curves and surface roughness of the object. This system of indication ensures equally reliable measurements in all application cases.

Thickness gauges allow to save the measurement results in the non-volatile memory.

The DataSaver software (DN) included in the delivery kit of the device, allows to transfer data from the device storage to an external personal computer (PC) for subsequent analysis, processing and documentation. The communication with a PC is done using the USB port.

1.1.2 Operating conditions

The instrument is intended for operation under the following conditions:

- Operating temperature range: from -30 to +55 °C;
- Relative air humidity up to 85 % at +35 °C.

1.2 TECHNICAL SPECIFICATIONS

The main technical specifications of the device are given in the Table 1.

Table 1

Parameter	Value
Thickness measurement range (for steel), mm: with the transducer S3567 2.5A0D10CL	0.8 to 300.0
Limits of the absolute permissible inaccuracy of the thickness measurement, mm, max., where H is the measured thickness in mm:	
at thickness from 0.7 to 3.0 mm	$\pm(0.01 \cdot H + 0.1)$
at thickness from 3.01 to 99.99 mm	$\pm(0.01 \cdot H + 0.05)$
at thickness from 100.0 to 300.0 mm	$\pm(0.01 \cdot H + 0.1)$
Thickness indication sensitivity, mm:	
at thickness up to 99.99 mm	0.01; 0.1
at thickness from 100.0 mm	0.1
Ultrasonic velocity setup range, m/s	500 to 19,999
Power	Inbuilt lithium battery
Rated supply voltage, V	3.7
Battery operation time, h, min.	9
Overall dimensions of the electronic unit, mm, max.	161X70X24
Weight of the electronic unit, gr., max.	210
Mean time between failures, h	18,000
Regular service life, years	5

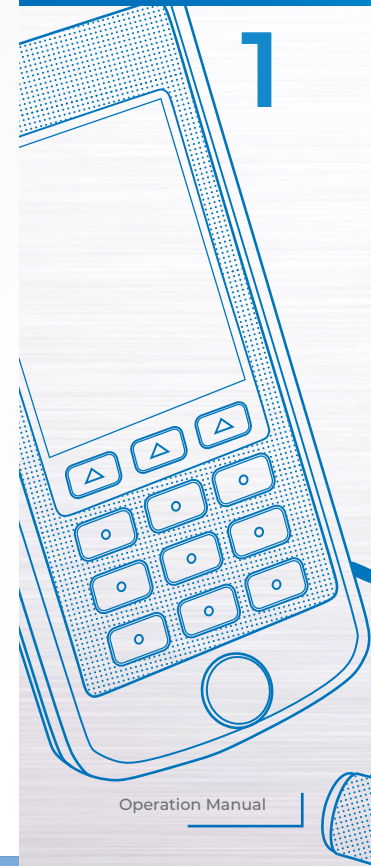

1.3 ARRANGEMENT AND OPERATION

1.3.1 Arrangement

The thickness gauge consists of an electronic block (Figure 1) with replaceable piezoelectric transducers. The device is connected using cables.

The colour TFT display is located in the upper part of the indication panel of the electronic block. It is used to display the measurement results and current information necessary to control the thickness gauge. The display enables to monitor the measurement process visually by means of color-coded indication.

Under the display there is a pressure switch of the thickness gauge.

To perform the automatic resetup of the device and the transducer with the ultrasonic probe and to estimate the operating capacity of the device a 5 mm thick calibration sample made of titanium with the ultrasonic speed of 6.180 km/s is placed on the lower part of the front panel.

The ports for connection of the piezoelectric transducers are located on the upper front side of the electronic block. One of ports is marked with a red dot (Figure 2).

On the lower front wall of the electronic block the USB Micro B socket is located. It is used to connect the USB cable with the PC and the 200 V USB power adapter to charge the built-in device battery (Figure 3).

The USB Micro B cable shall be connected with the  icon or the letter B looking down (Figure 4).



Figure 1

- Electronic block sockets
- Colour TFT display
- Membrane switch
- Calibration sample

Figure 2



Red point

Figure 3

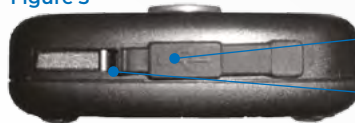

Socket USB MicroB

Electronic block fastening

Figure 4



1.3.2 Operating principle

The operating principle of the A1208 thickness gauge mainly includes the measurement of time needed for the ultrasonic waves to pass the tested object from one surface to another and the subsequent conversion of the measured values into the thickness parameter.

An ultrasonic transducer is used to emit the ultrasonic pulses into the TO and receive their reflections. The US transducer is placed on the surface of the TO where the thickness shall be measured. The ultrasonic transducer has a sharp emitting and receiving beam pattern, so the thickness is determined directly under the located transducer. In case there are cavities on the surface of the TO opposite to the installed transducer, the US pulses are reflected from the cavities, the thickness is determined as the shortest distance from the external surface to these cavities.

1.3.3 Operating modes

The thickness gauge can be used in the following modes:

- the measurement mode: here the measurement result is displayed in accordance with the appropriate set interval and the response parameter of the automatic flaw warning (AFW) STANDARD.
- the measurement mode: indication of the saved results i.e. MEMORY;
- the measurement mode: indication of the deviation of the measurement results from the set rated value i.e. PERMISSIBLE VALUE.
- the setup and measurement parameter selection mode: i.e. SETUP.

It is possible to save the results in the device memory in all measurement modes.

When in the STD mode, the thickness gauge measures the thickness of the TO and allows to quickly determine the appropriate set interval, in the percentage as well, and the response parameter of the AFW.

When in the MEMORY mode, the thickness gauge measures the thickness of the TO and allows to quickly determine the appropriate set interval and the response parameter of the AFW, view the measurement results saved in other modes on the display and correct the records performing repeated measurements and recording the information into the updatable memory cells.

The SETUP mode allows to change the selected conditions and parameters of measurements. The set of the parameters accessible to editing employs measurements common for all modes and measurements individual for each mode.

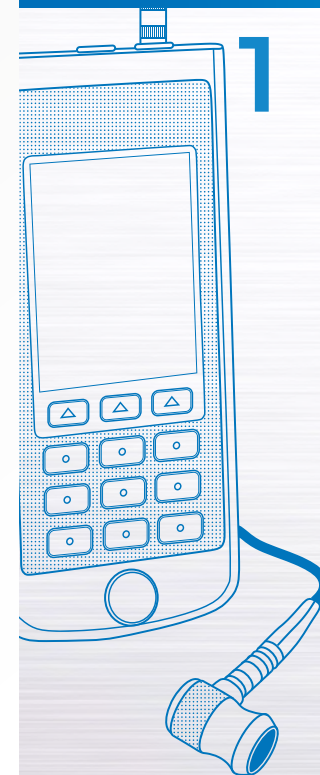



1

1.3.4 Display of the device

In all operating modes in the upper line of the display the information on the current operating mode of the device and the battery charge level is indicated.

The tab icons of different operating modes are given in the Table 2 below.

Table 2

Tab	Operating mode
	STANDARD
	MEMORY

The icons of the measurement mode are always located from left to right as follows: STANDARD – MEMORY. The active mode icon is highlighted yellow (Figure 5).

When you enter the SETUP its icon will be displayed instead of the icon of the mode, from where you entered the SETUP mode. All parameters and settings are now active and can be edited. (Figure 6).

Figure 5









Figure 6



The characters informing on the signal presence and level are always present in the STANDARD, MEMORY and PERMISSIBLE VALUE modes. Here you also read the information on the measurement method, units of measurement and the numerical value of the measurement result.

The description of the ultrasonic contact indicators and the measurement method is given in the Table 3.

Table 3

Indicator	Description
	Maximum signal. The receiving path amplification setting is minimum.
	Medium signal. The receiving path amplification setting is medium.
	Minimum signal. The receiving path amplification setting is maximum.
	There is no signal or the signal intensity is too weak to perform measurements.
	No measurements
	Measurements using the ACF
	Measurements using the threshold method



The display of the instrument in the STANDARD mode is given in Figure 7.
The display of the instrument in the MEMORY mode is given in Figure 8.

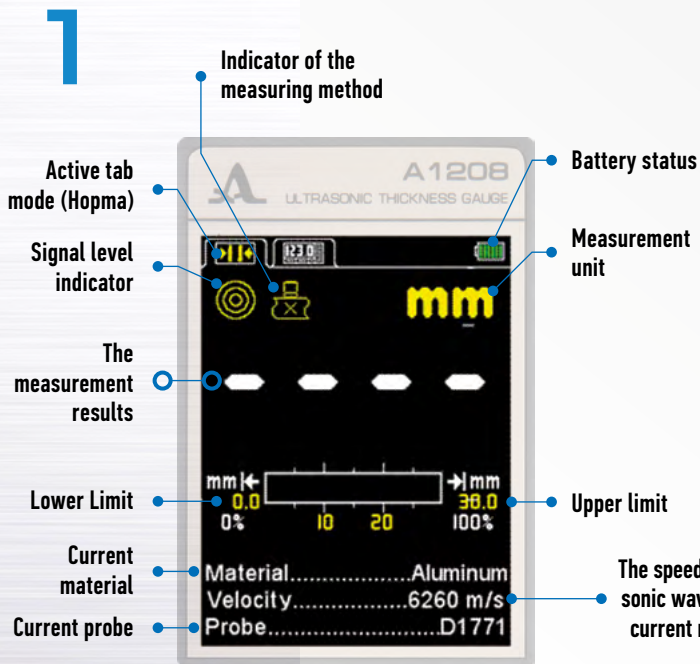

Figure 7

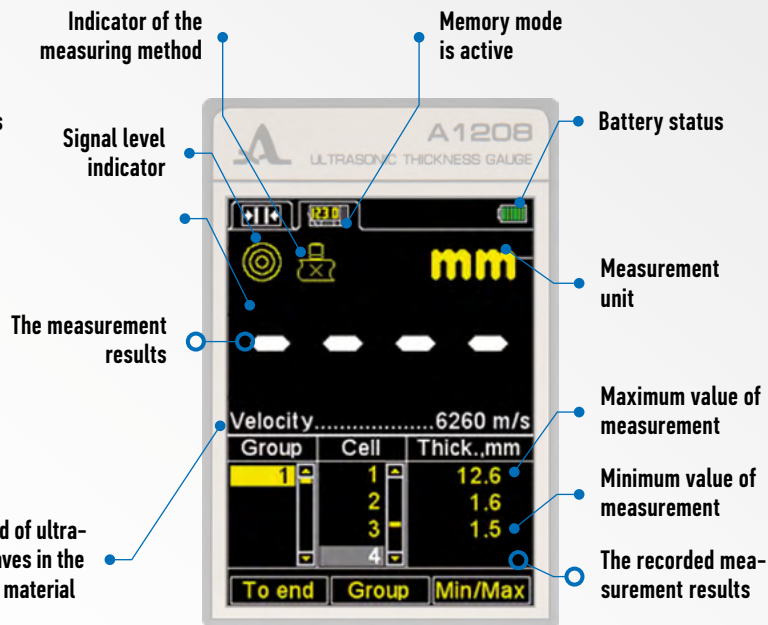



Figure 8

1.3.5 The device keyboard

The keyboard of the thickness gauge (Figure 9) contains 11 functional keys and the ON/OFF key.

The main key functions:

The ON/OFF key  is used to switch the device on and off.

NOTE: IF NO KEY IS PRESSED AND NO MEASUREMENT IS PERFORMED WITHIN 10 MINUTES, THE DEVICE IS AUTOMATICALLY SWITCHED OFF.

NOTE: IF NO KEY IS PRESSED AND NO MEASUREMENT IS PERFORMED WITHIN 2 MINUTES, THE SCREEN BRIGHTNESS IS AUTOMATICALLY REDUCED TO THE MINIMUM VALUE OF 20 %!

The functional keys  (F) carry out various actions, depending on the selected operating mode. The name of the current function is indicated on the display above each key. The functional keys are numbered in the present manual from left to right: F1, F2, F3 (Figure 10).

The Key  is used to change between the MEASUREMENT mode and the SETUP mode and back.

The Key  (ENTER) has various functions depending on the operating mode and the condition of the thickness gauge.







The keys  / ,  /  and  /  are used to select and change the active parameters. Their actions are similar for various operating modes of the device. They are ment for instinctive use. The icons of the keys reflect their functions.



Figure 10

F1

F2

F3

Figure 9



2

INTENDED USE

2.1 OPERATIONAL RESTRICTIONS

The device is intended for operation under the environmental conditions specified in the Section 1.1.2.

2.2 PREPARING THE DEVICE FOR USE

2.2.1 Preparation of the surface

Please clean the surface of the object to be tested, remove all dirt and sand and any corrosion, also remove all loose rust and put more liquid than in case of a smooth surface.

Cleaning of the rough corroded surface allows to prolong the transducer service life and to increase the measurement accuracy.

2.2.2 Connection of the transducer

To define the thickness of the object to be tested separately-combined and combined transducers are used.

Please connect the transducer observing the marking.

Two types of cables are used depending on the type of transducer. Accordingly, there are two ways of connection the piezoelectric transducers PT.

Separately-combined transducers are connected by means of a double cable with LEMO 00 plugs.

The cable with the red end shall be connected to the port with the red dot (Figure 11).



Figure 11

2.2.3 Switching the device On/Off

To switch on the device, please press the key .

The information on the device, its name and the number of the firmware version is displayed on the screen for several seconds (Figure 12).

The thickness gauge will automatically start in the mode which was active last time, when the device was switched off, all corresponding settings are saved.

In case the same transducer is connected to the device as the one that was used when the device was switched off last time, the device is immediately ready for operation. When you connect a different transducer, please first adjust the device to be able to work with the transducer.

The device is switched off manually by pressing the key  or automatically, if no key is pressed and no measurement is performed within 10 minutes.

All thickness gauge settings are saved when the device is switched off or the battery is completely discharged.

2.2.4 The setup of the device to the parameters of the used PET



Prior to start working with the device and in case you need to change the transducer, please perform the setup of the device to the individual parameters of the used PET.

2.2.4.1 Choosing the transducer

To choose the transducer, please:

Press the key  to enter the SETUP mode.

Using the keys   go to the PET item and press the key F3 (Open) or  to enter the transducer library (Figure 13).

Using the keys   go to the line with the name of the connected PET and press the key  to select it (Figure 14).

After the transducer is selected the PET testing process starts automatically, the device is adjusted to the individual parameters of the PET.

2

Figure 12

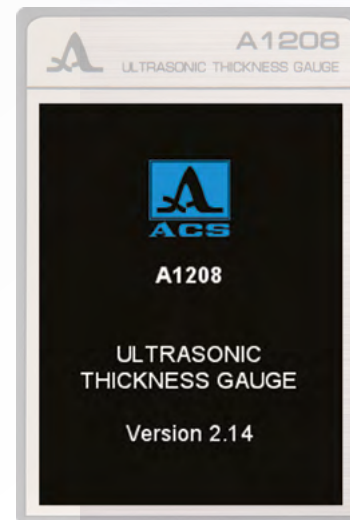

2

2.2.4.2 Setup of the instrument to the parameters of the used transducer

The setup is performed in two steps. At the first step the device automatically analyzes the features of the PET. At the second step it is adjusted to these features using the real echo-signal from the calibrator sample built in the device.

To adjust the device to the individual parameters of the PET, please:

- Enter the SETUP mode.
- Go to the line PET and press the key F1 (Test). The message “PET test, raise the PET, remove any oil and press ENTER” appears on the screen.
- Remove the contact liquid from the transducer and without contacting the calibration sample press .

The message: “Testing in process, please wait” appears on the screen. Wait for the message “TEST PET – install the PET on the calibration sample and press ENTER” to appear on the screen.

- Apply contact liquid on the calibration sample and put the transducer on it. Press the key .

The message: “Testing in process, please wait” appears on the screen. When the testing is completed the message on the testing results will appear on the screen. The result can be negative or positive (Figure 15).

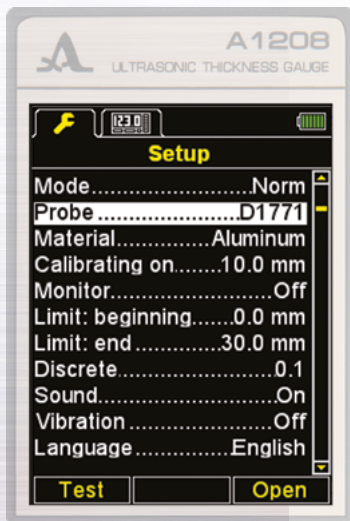

Figure 13

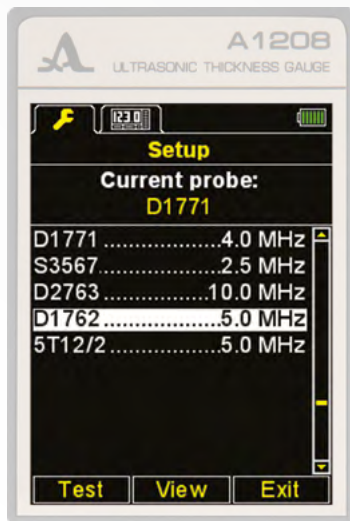

Figure 14



Figure 15

- Remove the transducer from the calibration sample.
- Press the key F2 (Ok). If the testing result is positive, the device will change to the measurement mode. If the testing result is negative, the device will return to the the main window of the SETUP mode.

By pressing the key F2 (Cancel), you may cancel the testing any time. In this case the device will return to the the main window of the SETUP mode.

On the Figure 15 you see the successful setup process and the appropriate display images.

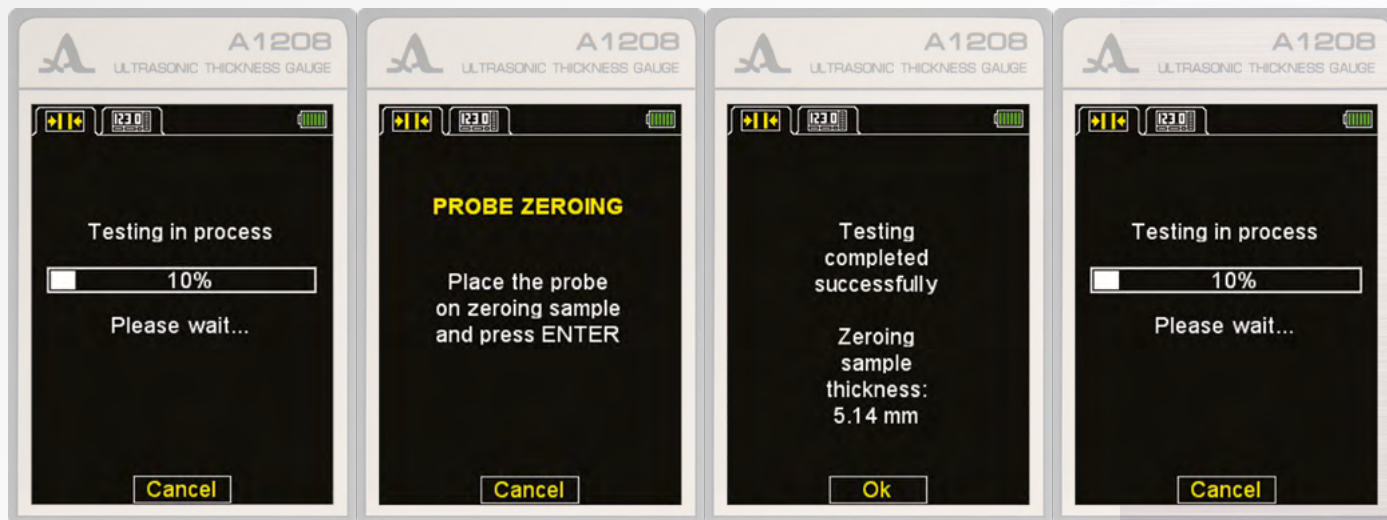
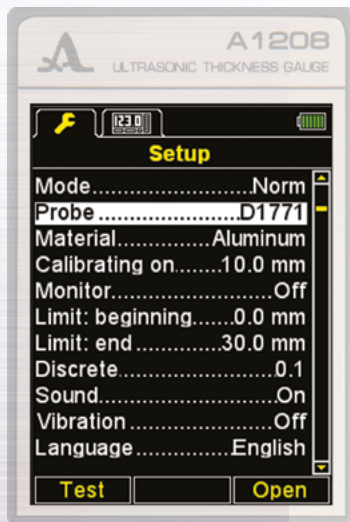

Figure 15

2

Figure 16



2.3 USING THE DEVICE

2.3.1 Work with the device

It is not recommended to slide the operating surface of the PET along the surface of the tested object, if it is not necessary. If you have to inspect the TO in several points and the tested object has a large surface, please lift the transducer and put it on the required points. Do not continuously scan the whole surface. Scanning accelerates the wear of the PET significantly. If it is necessary to perform the scanning, for example to determine the local material thinning, please perform it with utmost care without big pressure on the PET. Use only clean contact liquid and clean the surface from dirt prior to perform the scanning.

During the testing process please consider that the ultrasonic propagation velocity depends on the temperature of the tested material and differs in cold and warm objects.

To achieve the most accurate measurements, please set the device considering the ultrasonic velocity of the sample with the same temperature as the object to be tested.

It is recommended to remove all contact liquid from the ultrasonic transducer after finishing the work. A drop of liquid can lead to the reflected signal. The device will not be able to switch off automatically.







2.3.2 SETUP mode

In the SETUP mode you can perform the PT testing procedure, calibrate the velocity using the sample with a definite thickness, view the transducer library, work with the list if materials and view the list of parameters accessible to editing.

All device settings are saved when you switch off the device or when the battery is completely discharged.

The SETUP mode of the screen is shown on the Figure 16.

The following keys are active in any menu of the SETUP mode:

-   Moving up and down the menu items, the movement is done cyclically in both directions. The parameter in the active line can be selected and edited;
-   Selecting the category of numerical value for editing;
-   Reducing or increasing the numerical value of the selected parameter.

The items of the SETUP mode menu are identical for all measurement modes. The corresponding parameters and functions are listed in the Table 4.

Table 4

Menu item	Parameter value	Description
Mode	Standard/Memory/Permissible	Select the measurement mode
PT	Name of the PT	Enter the transducer reference list Start the testing procedure of the PT
Material	Name of the material	Enter the material reference list
Calibration by, mm	From 2 to 80 mm	Setting of the thickness of calibration sample. Starting the velocity calibration on the sample
Monitoring (automatic flaw warning)	Off / Beyond / Within	Off – turning off the monitoring function Beyond/within: tripping of the monitoring function when the result is beyond or within the previously set ranges
Limit: initial	0 to 150 mm	Setting the initial limit of the monitoring function
Limit: final	1 to 300 mm	Setting of final limit of the monitoring function
Discrete	0.01/0.1	Setting of the sampling rate of the result indication
Sound	On/Off	Sound setting
Vibration	On/Off	Vibration setting
Language	Rus/Eng.	Language selection
Measuring units	mm/inches	Measuring unit selection
Brightness	20 to 100%	Brightness setting

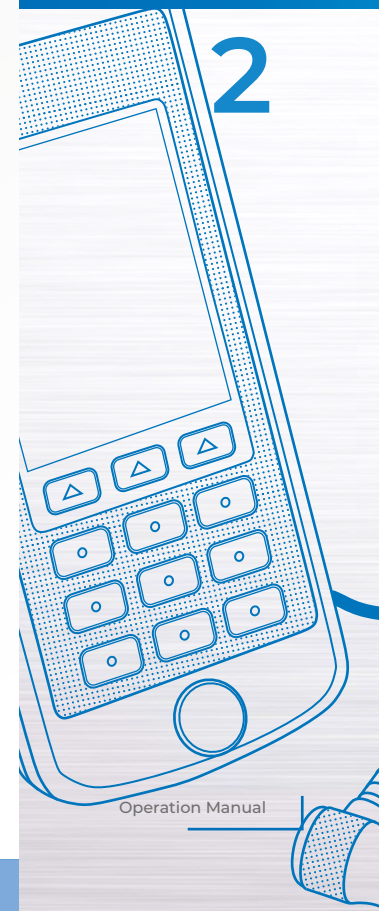

2

The additional menu items of the SETUP mode common to the modes STANDARD and MEMORY and corresponding parameters and functions are listed in the Table 5.

Table 5

Menu item	Parameter value	Description
Clear memory	0 – 100%	Deleting measurement results from the memory
Data transfer*		Start sending the results from the memory to a PC

* - Used only when the version of the DataSaver software is lower than 3.0 version. Starting from 3.0 versions, the operator doesn't have to do anything with the keyboard.

Figure 17

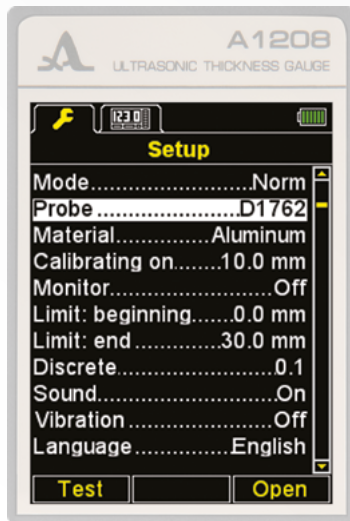
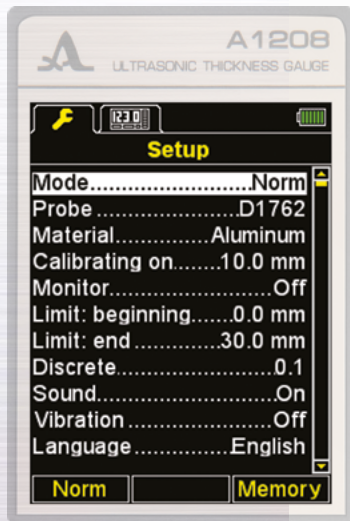

Figure 18

2.3.2.1 The item MODE

Selecting the measurement mode:

STANDARD without saving the measurement results;

MEMORY with saving the measurement results in the device memory.

PERMISSIBLE VALUE the level and the direction of the deviation of the TO measured thickness from the rated value is indicated.

Active keys:

F1 (Standard) select the Standard mode;

F3 (Memory) select the Memory mode;

 changing between the modes STANDARD /MEMORY.

The item MODE is shown in the Figure 17.

2.3.2.2 Item PT PROBE

Active keys:

F1 (Test) starting the PT testing procedure and the device setup to the selected transducer;

F3 (Open) or  enter the transducer reference list to view and select one.

The PT item is shown in the Figure 18.

The window shows the information on the currently used PET.

NOTE: THE USER DOES NOT HAVE THE POSSIBILITY TO MAKE CHANGES IN THE TRANSDUCER DATA BANK AND TO ADD TRANSDUCERS.

Active keys:

F1 (Review) viewing the detailed information on the transducers. The information on the name, type and frequency of the PT is shown on the screen.

F3 (Exit) – returning in the main window of the SETUP mode.

Using the  you select a transducer from the list. The PT testing procedure is then automatically started, the device is adjusted to the transducer parameters. The procedure is described in the Section 2.2.4.2 in detail.

When you exit the reference list, the device saves the last active line and uses it when you enter the list again. When the device is switched off the information on the active line is reset.

The device screens when viewing the transducer library are shown in the Figure 19.

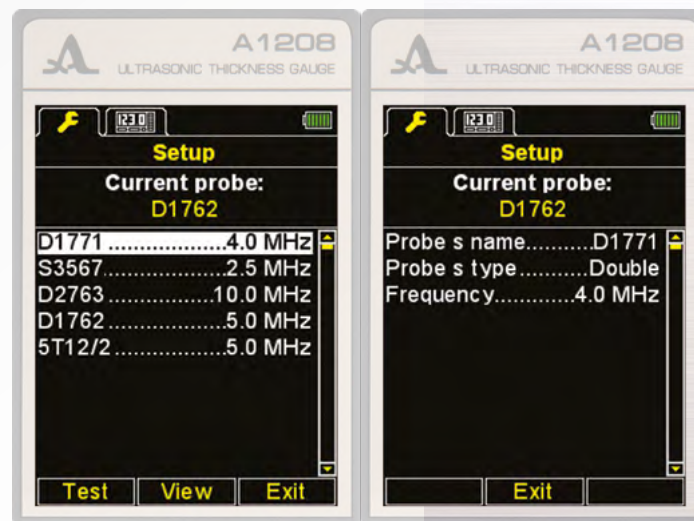



Figure 19

2

2.3.2.3. Item MATERIAL

Active keys:

F2 to open or  to enter the material base, record new and edit the existing materials in the memory and to select the material for further work.

The item MATERIAL is shown in the Figure 20.

Using the material library:

In the device memory the information on 64 materials can be stored.

In the upper line of the window the information on current used material and the ultrasonic velocity in this material is indicated.

Creating a new material:

The first menu item is NEW. It is followed by the name and the ultrasonic wave propagation velocity in a material saved in the device memory (Figure 21)

Active keys:

F1 (Create) opening the material editor (Figure 22).

F3 (Exit) returning to the main window of the SETUP mode.

When a new material is created or the information on the material saved in the device memory is edited, the current material name is indicated on the screen. The material name bears an inverse active symbol, the ultrasonic wave propagation velocity in the material and the tables of accessible symbols are indicated on the screen.

The main keys used to edit the names of materials are shown in the Table 6.

Figure 20

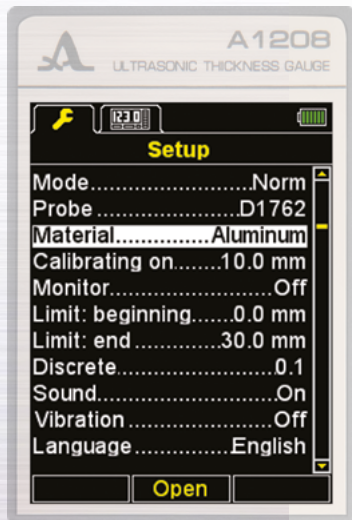





Figure 21

Table 6

Key	Intended use
	Moving in the table of characters
	Select a character for editing
	Replace the active character with a character from the table After the replacement, the next character becomes active
F1 (Save)	Exit and save the changes
F2 (XXX)	Changing the characters in the letter table where, XXX: аБв are russian small letters (for russian interface only) АБВ are russian capital letters abc are english small letters ABC are english capital letters
F3 (Exit)	Exit the editing without saving changes

Editing the information on a material.

Active keys:

F1 (Edit) go to the information editing of the selected material. The process of editing is similar to the creation of a new material described above.

F2 (Delete) delete the material from the device memory.

F3 (Exit) return to the main window of the SETUP mode.

 select a material for further work and return to the main window of the SETUP mode.

When you exit the library, the device saves the last active line and sets it when you return to the library. When the device is switched off, the information on the active line is reset.

2

Figure 22



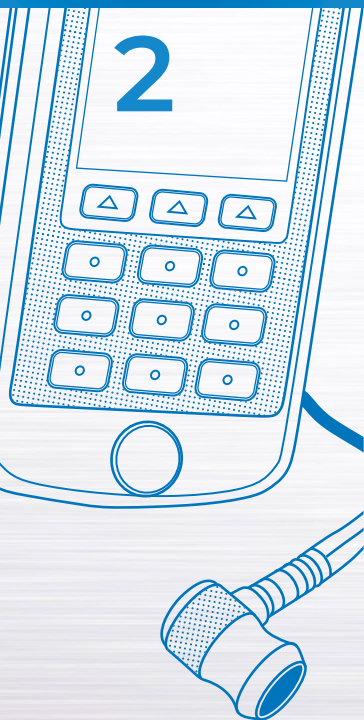

The library of materials is shown in the Figure 23.

If you press the key F2 (Delete) the message “Delete the selected material?” is indicated on the screen. (Figure 24). You can confirm the deletion by pressing F1 (Yes) or cancel it by pressing F3 (No).

2.3.2.4 Item CALIBRATION FOR

The item CALIBRATION FOR is used to define the ultrasonic wave velocity in the sample material with the given thickness.

The thickness of the calibration sample can be determined from 2.0 to 80.0 mm.

The item CALIBRATION FOR is shown in the Figure 25.

Active keys:

F1 (Execute) start the velocity calibration procedure on the sample.

F2 (Edit) setting the calibration sample thickness.

Installation of the calibration sample thickness and velocity calibration on the sample.

Please perform the velocity calibration as follows:

- Define the sample thickness.
- Start the velocity calibration procedure on the sample.
- The message “Put the transducer on the calibration sample and press ENTER” appears on the screen.
- Put contact liquid on the sample.
- Put the transducer on the sample and press



Figure 23



Figure 24

- The message “Data retrieval on the sample with the thickness XXX is in process”, appears on the screen, where XXX is the determined sample thickness.
 - The current result of the velocity measurement is indicated on the screen. When the data retrieval is completed, the velocity value will appear at the screen. The message “Save the result?” is indicated.
- On the Figure 26 you see the screens during the calibration procedure using the sample with a definite thickness.

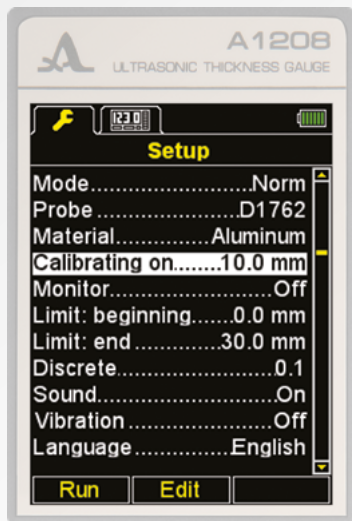

Figure 25

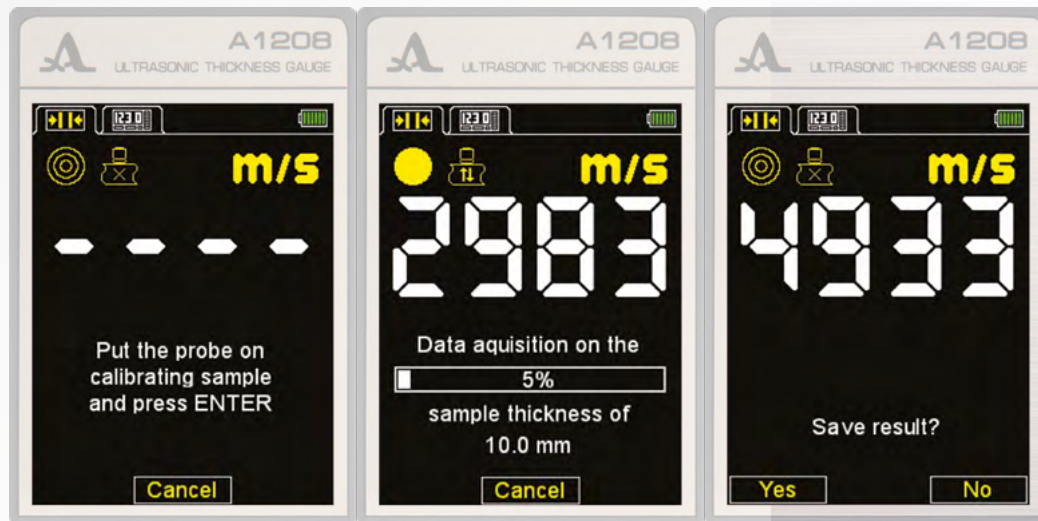

Figure 26

2

Saving the velocity values received during the calibration.

Active keys:

F1 (Yes) save the received velocity value for the material saved in the library (Figure 27) or create a new one (Figure 28).

F3 (No) exit without saving the results

Figure 27



Figure 28

2.3.2.5 Item Monitor

Setting the conditions for colour, acoustic and vibration alarm during the measurements.

Selecting the alarm conditions:

WITHIN means the measurement result is within the set interval;

BEYOND means the measurement result is beyond the set interval;

OFF means the monitor is switched off.

The item Monitor is shown in the Figure 29.

Active keys:

F1 (within) selecting the alarm conditions WITHIN;

F2 (OFF) the monitor is switched off;

F3 (beyond) selecting the alarm conditions BEYOND;

 Switching between the conditions WITHIN / OFF / BEYOND.

2.3.2.6 Item LIMIT: from

Setting the lower limit of the monitor activation.

The permissible values are from 0 to 150 mm.

The item LIMIT FROM is shown in the Figure 30.

Active keys:

F2 (Edit) setting the lower limit of the monitor activation.

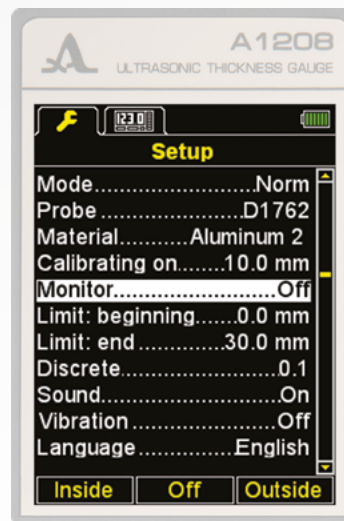

Figure 29

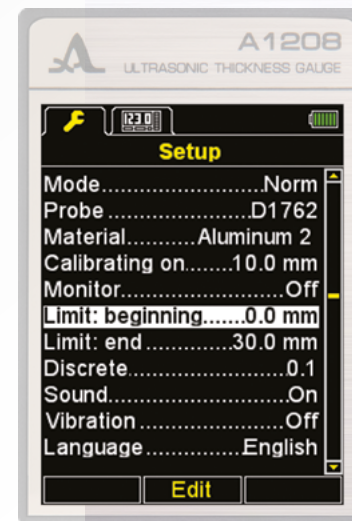

Figure 30



2



2.3.2.7 Item Limit: to

Setting the upper limit of the monitor activation.

The permissible values are from 1 to 300 mm.

The item LIMIT TO is shown in the Figure 31.

Active keys:

F2 (Edit.) setting the upper limit of the monitor activation.

2.3.2.8. Item Discrete

Setting the result of the image sensitivity on the screen.

The item Discrete is shown in the Figure 32.

Active keys:

F1 (0.1) setting the measurement results indication with one tenth;

F3 (0.01) setting the measurement results indication with one hundredth;

Switching between the sensitivity values 0.1 and 0.01.

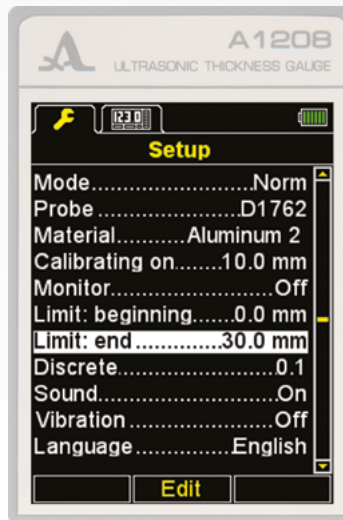

Figure 31

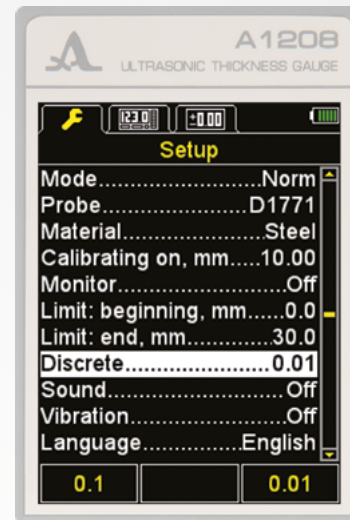

Figure 32

2.3.2.9 Item CLEAR MEMORY (in the mode MEMORY only)

Deleting the measurement results from the memory.

As the item parameter the percentage of the memory filling with the measurement results is given.

The item CLEAR MEMORY is shown in the Figure 33.

Active keys:

F2 (Done) or  start the memory cleaning procedure.

After you started the memory cleaning the following message appears on the screen: “The saved data

Continue?” (Figure 34).

Active keys:

F1 (Yes) confirm the data deletion.

F3 (No) cancel the data deletion.

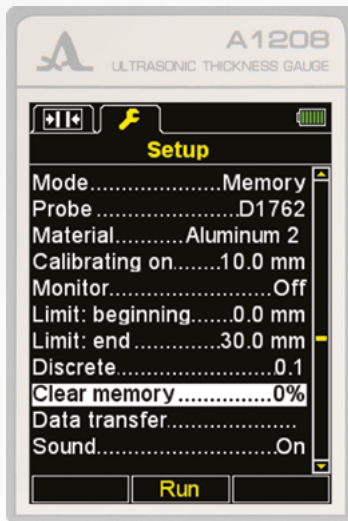

Figure 33



Figure 34

2

2

2.3.2.10 Item DATA TRANSFER (in the mode MEMORY only)

The data file saved in the memory of the thickness gauge can be transferred to a personal computer for the analysis, processing and documentation.

All results saved in the thickness gauge meter memory are transferred to a computer in groups in the same sequence as they were recorded.

When you transmit data to a PC, they are not deleted in the thickness gauge memory.

To transfer the recorded data from a PC to the thickness gauge please observe the transfer procedure of the measurement results to a PC:

Figure 35

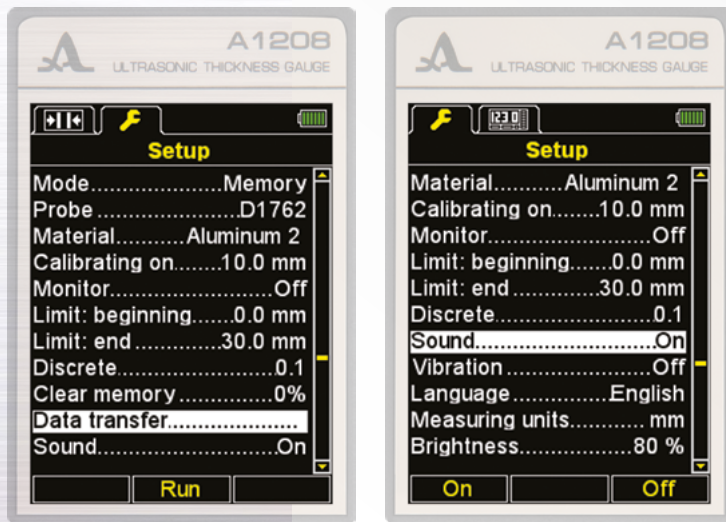

Figure 36

NOTE: YOU CAN ONLY USE THIS PROCEDURE WITH EARLIER VERSIONS OF THE DATASAVER PROGRAM. STARTING WITH THE VERSION 3.0 THE DATASAVER PROGRAM INITIATES THE DATA TRANSMISSION, NO ADDITIONAL ACTIONS AND NO USE OF DEVICE KEYS IS REQUIRED.

The item DATA TRANSFER is shown in the Figure 35.

Active keys:

F2 (Completed) or – start the data transfer of the measurement results from the device memory to a personal computer.

2.3.2.11 Item SOUND

Switching the sound indication of the device ON/OFF.

To increase the usability and the user friendliness of the thickness gauge the main events occurring inside it during measurements, settings and when pressing the keys are accompanied by acoustic signals. Acoustic signals allow to monitor the IS signal acoustically. Additionally, acoustic signals inform the operator on the current operations not influencing the measurement results.

The item SOUND is shown in the Figure 36.

Active keys:

F1 (On) Switching the sound indication On

F3 (Off) Switching the sound indication Off;

 Switching the sound indication On/Off.

2.3.2.12 Item VIBRATION

Switching the vibration of the device ON/OFF.

To increase the usability and the user friendliness of the thickness gauge the main events occurring inside it during measurements, settings and when pressing the keys are accompanied by vibration. Additionally, the vibration informs the operator on the current operations not influencing the measurement results.

The item VIBRATION is shown in the Figure 37.

Active keys:

F1 (On) Switching the vibration On.

F3 (Off) Switching the vibration Off;

Switching the vibration On/Off.



Figure 37

2

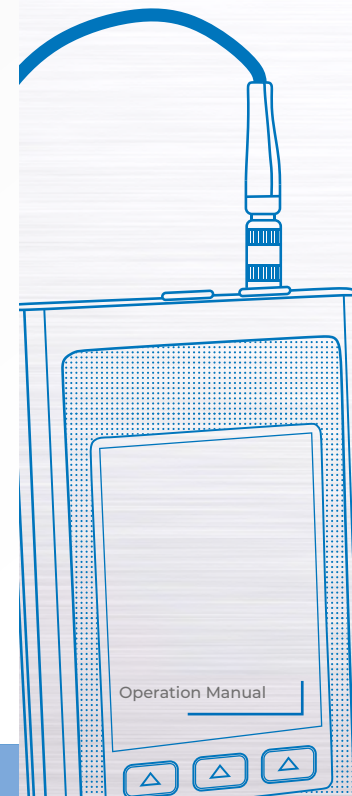

2

2.3.2.13 Item LANGUAGE

Selecting the language of the device interface: RUSSIAN or ENGLISH.

The item LANGUAGE is shown in the Figure 38.

Active keys:

F1 (Russian) Russian interface settings.

F3 (English) English interface settings;

 Switching between the interface languages.

Figure 38



Figure 39

2.3.2.14 Item UNITS of MEASUREMENT

Selecting the units of measurement: MM or INCHES.

The item UNIT of MEASUREMENT is shown in the Figure 39.

Active keys:

F1 (mm) metric measurement units. The thickness is displayed in mm, the velocity in km/s.

F3 (inches) imperial measurement units. The thickness is displayed in inches, the velocity in inch/mks;

 Switching between the units of measurement.

2.3.2.15 Item BRIGHTNESS

Setting the brightness of the display from 20 to 100 %.

The item BRIGHTNESS is shown on the Figure 40.

Active keys:

F1 (-) or  reduce the display brightness.

F3 (+) or  increase the display brightness.

2.3.3 The MONITORING Mode

If no measurement results are required it is recommended to use the MONITORING mode. To carry out measurements it is necessary to apply contact liquid to the surface of the object to be tested. Place the transducer on the surface you want to inspect. In the upper left corner there is the ultrasonic signal strength indicator and the measurement method indicator.

When the acoustic warning is on, the readings on the display are accompanied by short acoustic signals.

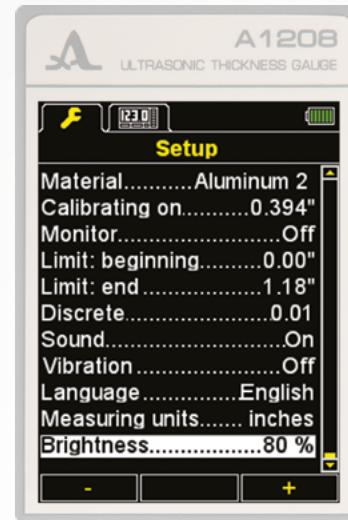

Figure 40

2

2

On the Figure 41 you see the device screen in the MONITORING mode when selecting the operating condition AFW WITHIN or BEYOND. If the operating conditions are fulfilled, the measurement result is indicated in red. White color means the condition is not fulfilled.

Active keys:



Changing the ultrasonic wave velocity in the material. If the indication on the screen is instable and the acoustic warning is on, please wait for the ultrasonic transducer to stabilize and show constant values.

NOTE: WHEN YOU REMOVE THE ULTRASONIC TRANSDUCER FROM THE SURFACE OF THE INSPECTED OBJECT, THE MEASUREMENT RESULTS DISAPPEAR AND YOU SEE HORIZONTAL STROKES!



Figure 41

2.3.4 MEMORY mode

In the MEMORY mode the screen is divided in two windows. In the upper window you see the information on the measurement similar to the MONITORING mode (thickness, signal level, measurement method). In the lower part the information on the previously saved results is indicated (groups, cells of groups and results). Here you also see the smallest and the biggest values of the current measurement results (Figure 42).

Active keys:

F1 (to the last) go to the empty cell of the last existing group (the next cell after the recorded cell).

F2 (group) add a new or delete the last group.

F3 (min/max) deleting of the Min and Max values for the current measurement.

 save the measurement results in the current group. To record results, it is possible to choose any existing group prior to the measurement process or during it.

 view and update the measurement results recorded in the device memory.

2.3.4.1 Add a new or delete the last group

By pressing the key F2 the message “Add / + / new or delete last group?” will appear on the screen (Figure 43).

Active keys:

F1 (-) delete the group.

F2 (Cancel) exit the window.

F3 (+) add a new group provided that the last existing group is not empty.



Figure 42



Figure 43

2

Figure 44

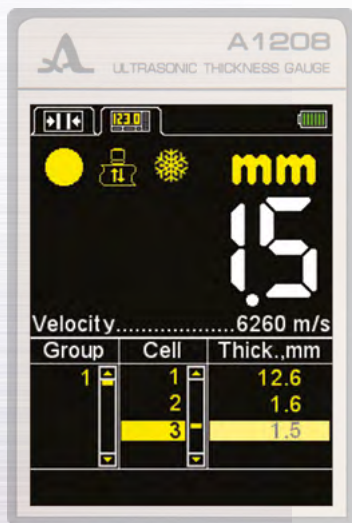

2.3.4.2 Save results

Measurement results are stored in the device memory in cells, which form groups. Groups and cells in groups are identified by serial numbers. Groups and cells in each group are numbered, started with number ONE.

The maximum number of cells in a group is 500.

The maximum number of groups is 100.

As soon as the maximum number of groups or the maximum number of cells in a group is reached, the corresponding message will appear on the screen.



Note: if the measurement result does not conform with the permissible range, the measurement is considered incorrect.

From experience it is more comfortable to record the results in small groups with several dozens of parameters. If necessary, you can return to any existing group and continue recording the results in this group (see 2.3.4.1).



To record the measurement please select any existing group or create a new one before you start the measurements. After the measurement process is finished please press ENTER. The measurement results will be saved in the first empty cell of the current (selected) group.

2.3.4.3 View and adjust of the measurement results





Any result recorded the device memory can be viewed. If you have any doubts concerning its reliability, you can correct it by performing a new measurement in the same point and recording it.

The key  is used to enter the View mode and edit the results. By pressing the key  the symbol  appears on the screen (Figure 44).

Using the key  you return to the MEMORY mode.

For viewing the recorded results, please use the keys  . Moving within one group of cells you see the measurement results according to the selected direction of viewing. As soon as you reach the last/first cell in a group, you will move to the next or the previous group of results accordingly.

To to correct the results, please:

Using the keys   go to the cell, where result is recorded, which you want to specify. Press the key , the symbol  will be gone.

Note: as a matter of fact, the result remains in the device memory until a new value is recorded in the selected cell. To return to the view mode, without changing the value recorded in the cell please press .

Perform the measurement. If the result is satisfactory, press  to record the result in the cell selected for correction. After result recording the device will automatically return to the view mode.

2.4.1.1 Performing MEASUREMENTS

Prior to measure the thickness, please select a transducer from the reference list. Adjust the device and select a material to perform the measurement. If the set material velocity differs from the actual velocity, please correct the velocity manually or perform calibration.

The more accurate the velocity setting, the more accurate are the measurements. If estimation is allowed during the measurements, please use the table given in the Annex A and set the value specified in the Table.

If you need accurate results, please take a sample from the same material as the inspected object and adjust the velocity according to it. Please set the velocity using the same PET, that will be used to perform the measurements. The best solution is to use a plane parallel sample with smooth surfaces. Please remember, the bigger the thickness of the sample (within the accessible range) and the better the quality of its surface, the more accurate will be the device setup to the ultrasonic velocity of the sample.

During the measurements ensure the place where you put the transducer is clean, covered with liquid and has no rough edges or cavities preventing the transducer installation on the surface. If it is not possible to install a transducer on the bottom of the cavity, you will not receive measurement results.

1.1.1 Measurements using a separated combined transducer

To measure a flat object, please press the PT to the object surface carefully and wait for 1 to 2 seconds for the excess liquid to come out under the transducer 1 2. The readings will stabilize within this time and will not change. Without lifting the transducer from the surface of the tested object read the measurement result on the screen or save it in the device memory, depending on the selected measurement mode.

If the surface is covered with slag, please remove the loose slag and corrosion and apply more liquid than with a smooth surface. When the ultrasonic contact indication is absent, the measurement results will not be indicated on the screen.

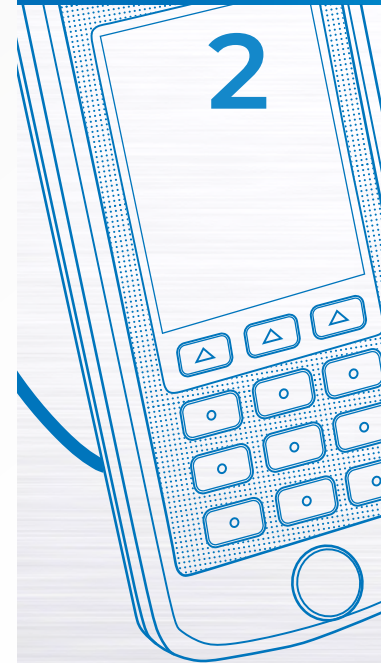

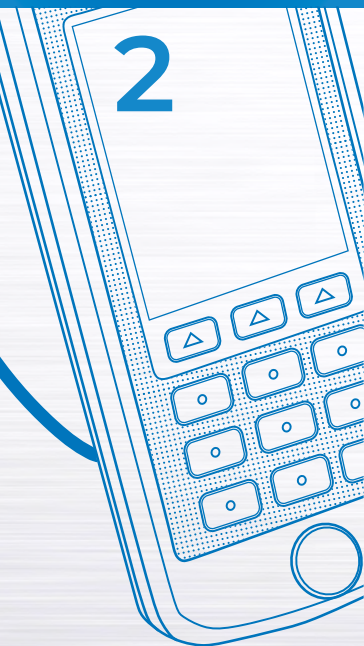

Please perform the testing again after thorough cleaning the contact place from corrosion. Always remove rough edges and corrosion from the TO, as this increases the measurement accuracy and allows to increase the service life of the PT.

To test circular objects, please follow some important steps. To measure the wall thickness of a pipe, especially of pipes with small diameter, please use more viscous liquids than transformer oil or water. Apply more liquid to the contact place. The screen dividing the vision blocks of the separated-combined transducer shall be positioned across the pipe axis. The light strip at the end of the transducer is located along the working surface diameter. Press the transducer to the pipe wall and observe the device readings, then slowly tilt the transducer within the cross-section plane of the pipe in both sides. Please mind however, you have to roll the transducer along the pipe wall and do not slide along the wall. When the transducer deviates from the neutral position the device readings will increase. Commonly the readings are minimal in the position where the transducer touches the pipe walls in the middle of its operating surface, i.e. when the longitudinal transducer axis crosses the pipe axis. When the transducer highly deviates from this position the readings increase explosively. As the correct value of the measured thickness please take the smallest stable reading of the device when the PET contacts the pipe wall in the middle of the operating surface.

1.1.1.2 Measurements using a combined transducer

As soon as the PT touches the surface of the TO in a fraction of a second the reliable ultrasonic contact of the transducer and TO is established. The first readings appear on the screen. These readings may differ insignificantly on pipes with small diameters when the transducer is shaking. On flat objects the readings are stable.

When measuring flat metallic objects with the thickness 4 to 5 mm and less do not use a very thin coating of contact liquid, i.e. do not press the transducer to the surface and do not rub on the surface. It is enough to press slightly for the thickness gauge to start indicating the measurement result. From this moment the readings do not change essentially.

When the thickness of a flat object is more than 20 mm please ensure the transducer is well pressed to the surface.

The pipe wall thickness measurement is especially easy to perform, as you do not have to align the transducer with the generating line of the pipe. It is also not necessary to rock the transducer on the pipe to find the smallest measured value. It is enough to place the middle of the operating surface of the transducer on the generating line of the pipe approximately. Please always use a thick liquid, e.g. mineral fat or lithol.

When measuring the thickness of objects with a double convex surface ensure the testes object is in contact with the middle of the transducer operating surface.

When you deal with TO with rough or uneven surface combined transducers offer more advantages compared to separated-combined transducers. Combined transducers allow to perform scanning along the surface even with rough surfaces and rests of abrasive particles. This is useful when searching for places with thinnings. At this please use more viscous contact liquids, e.g. mineral motor oil.

In any case wait 1 to 2 seconds after the readings appear on the screen to evaluate their reliability 1 2. Now do not remove the transducer from the surface of the TO und read the measurement results from the screen or save them in the memory.

1.1.1.3 Checking the functionality of the device during testing

In case you doubt the measurement result of the device please use the calibration sample from the delivery kit. It is 5 mm thick. Its ultrasonic velocity is 6180 km/s.

Please set the ultrasonic velocity of the device to 6180 km/s. Apply contact liquid to the sample and place the ultrasonic transducer on it. If the device operates properly, the thickness measurement result will be 5 mm considering the measurement errors.

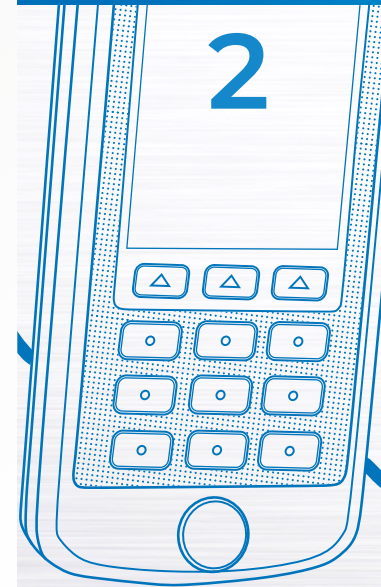



3

MAINTENANCE

The maintenance of the device includes cleaning of the electronic unit from dirt and dust and loading the battery.

3.1 BATTERY

The device battery can be used in a wide temperature range from -30° to $+50^{\circ}$ °C. In the lower temperature range the battery capacity is app. 15% lower than under normal temperatures. When the battery is completely discharged the device will be automatically switched off. There is an internal overcharge protection, overcurrent protection and temperature protection inside the battery. The battery lifetime is rated for the guaranteed service period of the device. The battery can only be changed by a service center.

PLEASE NOTE: THE USER MAY NOT EXCHANGE THE BATTERY ON HIS OWN AS THIS LEADS TO THE ANNULMENT OF THE WARRANTY FOR THE DEVICE!

3.2 CHARGING THE BATTERY

The battery can be charged from an external charger or a PC using the USB port.

The loading time of the battery depends on the level of its discharge. To completely load the battery you will need 4 to 5 hours. Repeated recharging is allowed.

The device can be operated during the process of loading from an external charger, in this case the loading time will increase by 2 to 3 times.

PLEASE NOTE: TO AVOID THE BATTERY FAILURE NEVER STORE THE INSTRUMENT WITH BATTERY DISCHARGED.

3.3 POSSIBLE MALFUNCTIONS

When malfunctions occur during the device operation or if you you have any questions on how to use the device, please contact the manufacturer representatives.

Please store the device in the rigid suitcase from the scope of delivery. The storage conditions must conform with the relevant international standards (see chapter 1.3).

Please store the device on a shelf.

The arrangement of the devices in warehouses shall enable their free movement and unrestricted access to them.

The distance between the device and the walls and floor of the warehouse shall be at least 100 mm.

The distance between heating units of the warehouse and the device should be min. 0.5 m.

The storage room shall be free from the current-conducting dust, aggressive gases and corrosive vapors able to attack the instruments.

4

STORAGE



5

TRANSPOR- TATION

Please transport the device in the rigid suitcase from the scope of delivery.
Packaged instruments can be transported at any distances and with any kind of vehicle without speed restrictions.
Packaged instruments should be properly and steadily fasted during transportation. When transported in open vehicles the instruments shall be protected from rain and water splashes.
The arrangement and fixation of the packed instruments in transportation vehicles should provide their stable position and exclude strokes against each other as well as against the walls of the transportation vehicles.
The conditions for instrument transportation should meet the requirements of the valid specifications, rules and standards for each type of transport.
If shipped by air, properly packed instruments should be placed in hermetically sealed heated compartments.
When instruments are transported under the temperatures different to their operating temperature, please put the instrument into the regular conditions and wait at least two hours before starting to use it.

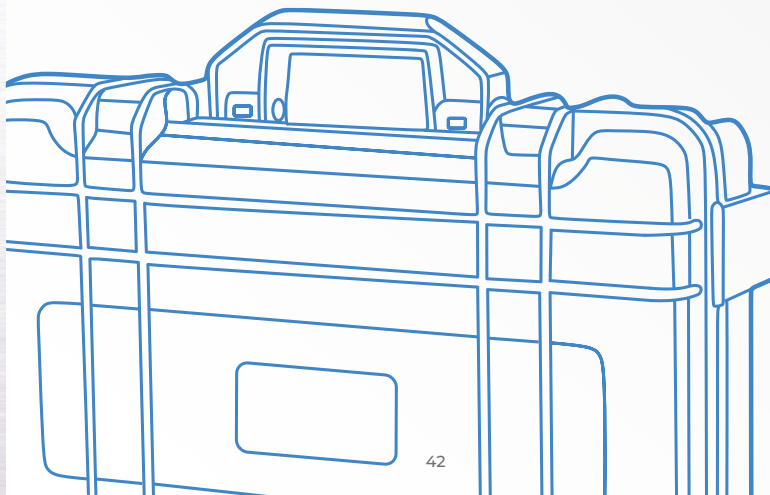

The propagation velocity of longitudinal ultrasonic waves in some materials are specified in the Table A.1

Table A.1

Material	Velocity, m/s	Material	Velocity, m/s
aluminium	6260	concretes	2000 – 5400
aluminum alloy D16T	6320	touchstone	5930
bronze (phosphorous)	3530	gabbro 38	6320
vanadium	6000	gypsum	4790
bismuth	2180	gneiss	7870
wolframite	5460	basil	4450
ferrum	5850	diabase 85	5800
gold	3240	magnesian lime	4450
konstantan	5240	limestone	6130
brass	4430	limestone 86	4640
brass LS-59-1	4360	nylon 6	2640
magnesium	5790	silica molten	5930
manganin	4660	labradorite 44	5450
manganese	5561	solid water	3980
copper	4700	marble	6150
molybdenum	6290	plexiglass	2670
nickel	5630	polystyrene	2350
stannum	3320	rubber	1480

APPENDIX A



▼ Table A.1

Material	Velocity, m/s	Material	Velocity, m/s
osmium	5478	mica	7760
plumbum	2160	organic glass	2550
silver	3600	silicious glass	5500
glass-ceramics	6740	steel Ch15H15GS	5400
steel 20 GSNDM	6060	steel St3	5930
steel ChN77TYUR	6080	cloth laminate	2920
steel 40ChNMA	5600	teflon	1350
steel ChN70VMTYU	5960	porcelain	5340
steel ChN35VT	5680	solid rubber	2400
tantalus	4235	zirconium	4900
chrome	6845	cast iron	3500 – 5600
zinc	4170		

APPENDIX A



NOTES



ULTRASONIC THICKNESS GAUGE

A1208



OPERATION MANUAL

Revision: February 2019